

NBM2317 SM-ChiP (Non-Isolated Bus Converter Module) Evaluation Board

Ankur Patel
Jon Siegers
Applications Engineer



Contents	Page
Introduction	1
Contents	2
Features	2
Board Description	3
General Components	3
Test Point Description	4
Bill of Materials	8
Recommended Test Equipment	9
Basic Connections and Operation	9
Paralleling	10
Thermal Considerations	10



Introduction

The NBM2317 (Non-isolated Bus converter Module) evaluation board described in this document is designed to be used with the NBM2317 SM-ChiP family of non-isolated, fixed-ratio, bidirectional DC-DC Bus converters.

The focus of this document is to assist the user in evaluating of the NBM2317 SM-ChiP™ family.

The NBM™ evaluation board can be configured for various enabling and fault monitoring schemes, as well as to exercise various loading conditions depending on the application requirements. The evaluation board can be used to evaluate NBMs in either a stand-alone configuration or as an array of modules.

It is important to remember that the fast response of NBMs can readily show the limitations of the source, load and associated wiring connected to the evaluation board. Care should be taken to minimize the source impedance as well as high- and low-voltage side interconnect impedances in order to fully realize the NBM performance.

The NBM non-isolated topology allows start up in step-down and step-up directions and provides bidirectional protections. However, if the powertrain is disabled by any fault protection and low side voltage V_{LO} is present, a voltage V_{HI} equal to V_{LO} minus three diode drops will appear on the high-voltage side.



IMPORTANT NOTICE:

Read the precautions below entirely BEFORE using the NBM™ Evaluation Board. Do not operate the evaluation board unless you have the appropriate safety precautions in place on your bench to guarantee safety.

The list below is not comprehensive and is not a substitute for common sense and good practice.

- During operation, the power devices and surrounding structures can be operated safely at high temperatures.
- Remove power and use caution when connecting and disconnecting test probes and interface lines to avoid inadvertent short circuits and contact with hot surfaces.
- When testing electronic products always use approved safety glasses. Follow good laboratory practice and procedures.
- Care should be taken to protect the user from accidental contact when under power.
- Care should be taken to avoid reversing polarities if connecting to the opposite (solder) side of the board.
- The product evaluation boards described in this document are designed for general laboratory evaluation and are not suitable for installation in end-user equipment.
- Refer to the specific NBM module data sheet for electrical, thermal and mechanical product details.

Contents

The evaluation board demo assembly ships with the following contents:

- 1 x NBM evaluation board
- 1 x coldplate and mounting hardware

Features

The NBM evaluation board has the following features:

1. Bidirectional NBM2317 SM-ChiP
2. Input and output bulk capacitance pre-charge circuit
3. Basic input and output filtering - using low ESR ceramic capacitors
4. Test points for NBM signal pins (TM/OG and EN)
5. Kelvin voltage test points for all power pins for input and output voltage measurements

Board Description

This board provides a convenient way to evaluate or demonstrate the performance of the Vicor NBM2317 SMChiP™ products. Kelvin connections are provided for accurate voltage measurements on power nodes and signals. The evaluation board also provides lugs for input / output connections and test points for easy connection to standard test equipment.

The following section provides a detailed description of the evaluation board components and test points. The evaluation board is bidirectional, with pre-charge circuitry for bulk capacitance included on both the high- and low-voltage sides. The board silkscreen has been designed to be read in both directions. The board is oriented based on the desired direction of operation such that "STEP UP" or "STEP DOWN" can be read at the top of the PCB, as shown in the below figure.

Figure 1
Evaluation board photo,
step up (left)
step down (right)

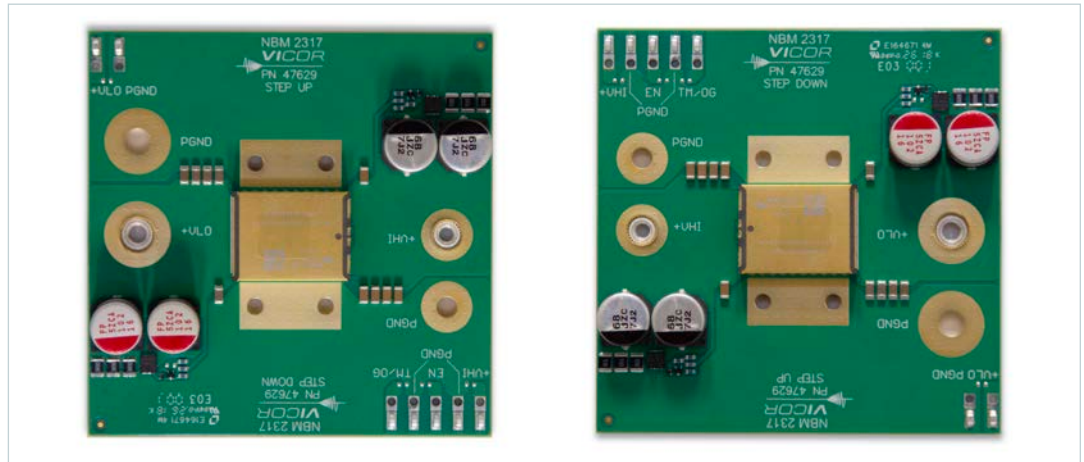

General Components

1. **NBM (PS10):** Non-isolated, fixed-ratio, bidirectional NBM2317 SM-ChiP.
2. **High-voltage-side lugs (H10 and H17):** H10 is labeled as +VHI and H17 is labeled as PGND. Use these lugs for making connections to the input source for step-down NBM™ operation or output load for the step-up NBM operation. This board does not contain reverse polarity protection. Check for proper polarity before applying the power. It is important to remember that noise from the source and wiring or interconnect-associated voltage drops will appear at the output of the bus converter multiplied by transformation ratio (K). The K factor is the ratio of the output voltage to the input voltage (V_{OUT} / V_{IN}).
3. **Input and output filtering:** The NBM operates at a fixed switching frequency greater than 1MHz. Low ESR ceramic capacitance are included on the board to minimize the switching voltage ripple. The evaluation board contains five 22µF/25V rated ceramic capacitors on low-voltage side and five 2.2µF/100V rated ceramic capacitors on the high-voltage side.
4. **Signal Test points (TP11, TP12 and TP16):** The TM/OG and EN signal pins are accessible through dedicated signal test points. Both signal pins are referenced to the PGND pin. TP11 is Kelvin connected to PGND and acts as a SGND reference for both signals.
 - **Temperature Monitor (TM):** The NBM TM/OG pin provides equivalent voltage output for internal controller-junction temperature. It measures 3V for a 27°C internal temperature. TM voltage increases / decreases by 10mV/°C.
 - **Output Good (OG):** The NBM TM/OG pin can be used as a fault flag. It is internally pulled low during a fault condition. The TM/OG pin can also be used as a ready to process power flag. This pin is internally pulled high at the end of soft start, indicating when load can be applied.
 - **Enable Control (EN):** Connecting the NBM EN pin to PGND disables the module. An external logic circuit can be used to turn off the powertrain and disable the module. The (EN) pin is internally pulled up to 5V. The EN test point can be used to bus the EN pin in an array configuration, allowing array synchronous start up. Note that EN pin doesn't have current sink capability. Therefore, in an array, EN line will not be capable of disabling all the modules if a fault occurs on one of them. Moreover, EN pin should not be driven high by applying the external voltage source directly to it.

5. **Low-voltage-side lugs (H18 and H19):** H18 is labeled as +VLO and H19 is labeled as PGND. Use these lugs for making connection to the output load for the step-down NBM™ operation or to the input source for the step-up NBM operation. This board does not contain reverse polarity protection. Check for proper polarity before applying the power. It is important to remember that noise from the source and wiring or interconnect-associated voltage drops will appear at the output of the bus converter multiplied by transformation ratio (K). The K factor is the ratio of the output voltage to the input voltage (V_{OUT} / V_{IN}).
6. **Power node test points (TP13, TP14, TP15 and TP17):** Dedicated test points are provided for making accurate measurements of the input and output voltage and voltage ripple. TP13 and TP17 are Kelvin connected to PGND and acts as a GND reference for both input and output voltage signals.
7. **Thermal ground interface (HS01):** A thermal ground interface is located on bottom side of PCB and is sized for NBM2317 SM-ChiP package. The footprint provides a convenient means to interface a heat-sinking element from the top and bottom side of the board.
8. **Input and output bulk capacitance pre-charge circuits:** The board contains the two pre-charge circuits for bulk capacitance. On the high-voltage side, circuitry is included for charging bulk capacitance C02 and C06. On the low-voltage side, circuitry is included for charging bulk capacitance C10 and C11. Note that precharging of bulk capacitance is not a requirement in any direction of operation if the output capacitance is within rated C_{HI-EXT} or C_{LO-EXT} , depending on direction of operation. Precharging circuitry has been added to the evaluation board to further reduce inrush current and to simplify operation in test setups in which additional holdup capacitance is needed to compensate for high source impedance.

Test Point Description

All test nodes are labeled and include an SMT test point for attaching miniature probes, clips or hooks.

Table 1
Test point descriptions

Name	Description
+V _{HI} , PGND	High-voltage-side test point. Kelvin connections provided for the NBM high-voltage side power pins.
EN, PGND	EN pin relative to PGND pin. Kelvin connection provided to the NBM EN signal pin..
TM/OG, PGND	TM/OG signal relative to PGND pin. Kelvin connection provided to the NBM TM/OG signal pin.
+V _{LO} , PGND	Low-voltage-side test point. Kelvin connections provided for the NBM low-voltage side power pins.

Please note: The PGND is a common-power / signal-ground reference for the high-voltage-side and low-voltage-side power and signal pins of the NBM.

Figure 2a
PCB#47629 evaluation board
photo, top side

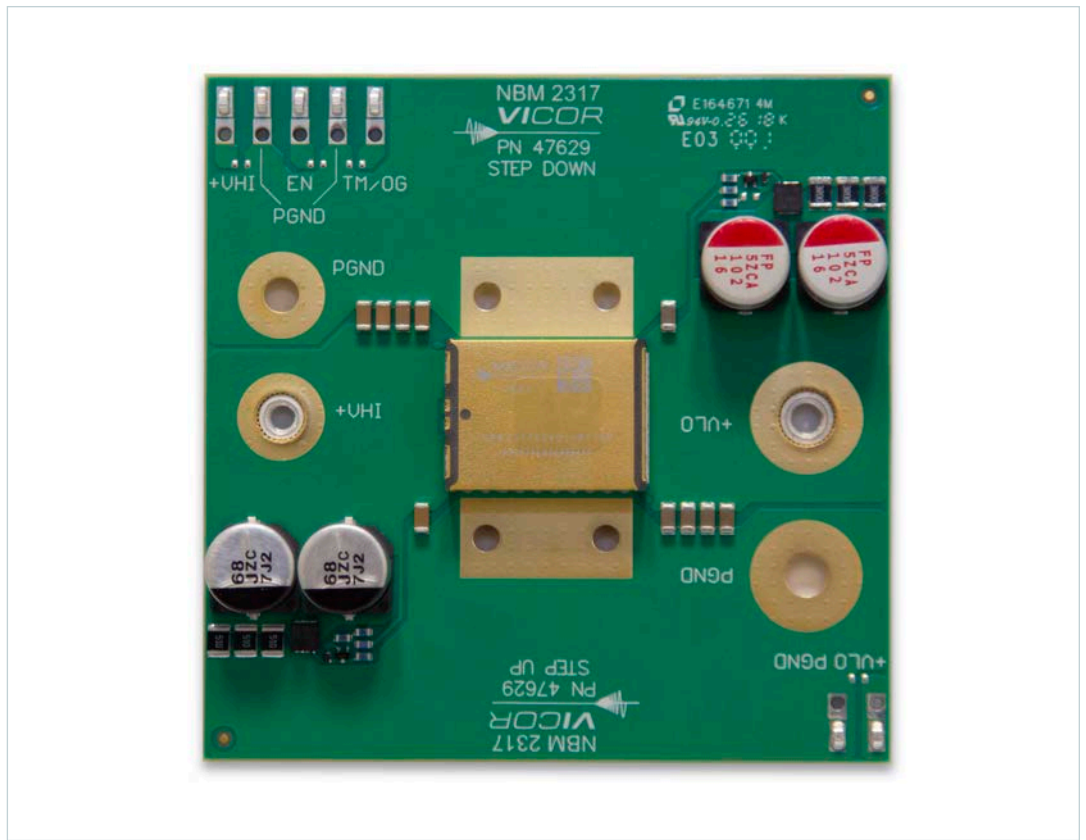

Figure 2b
PCB#47629 evaluation board
photo, bottom side

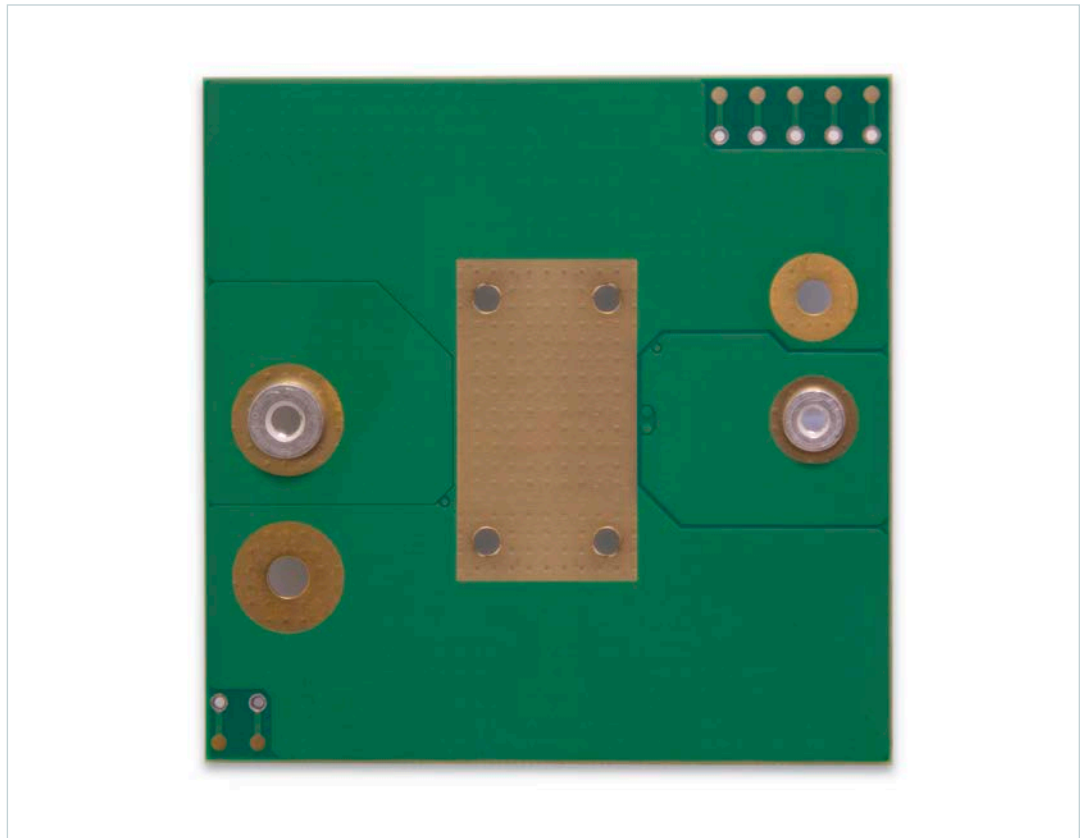
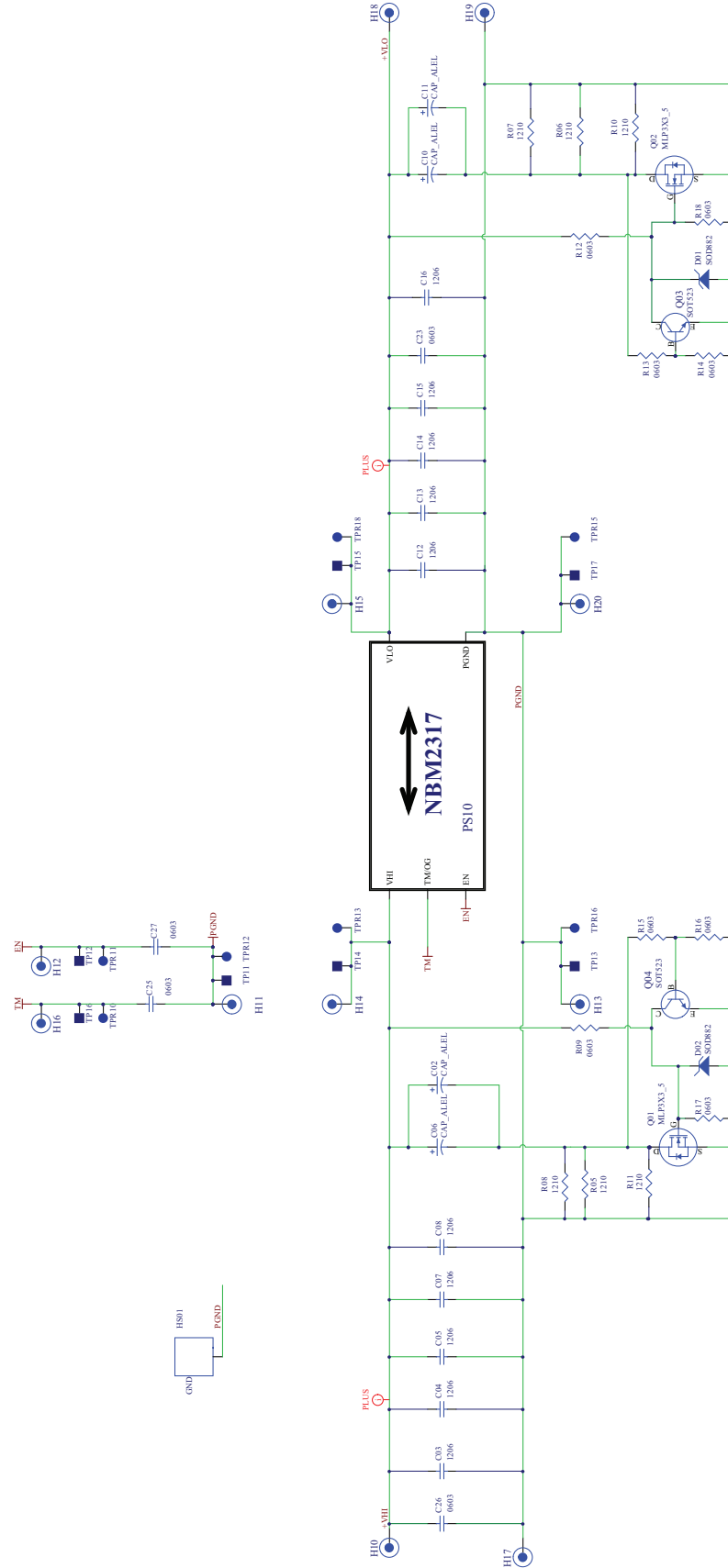

Figure 3
PCB#47629 evaluation
board schematic



FID01 FID02
FID03A1 FID03A2

Figure 4a
PCB#47629 evaluation board
assembly drawing, top side

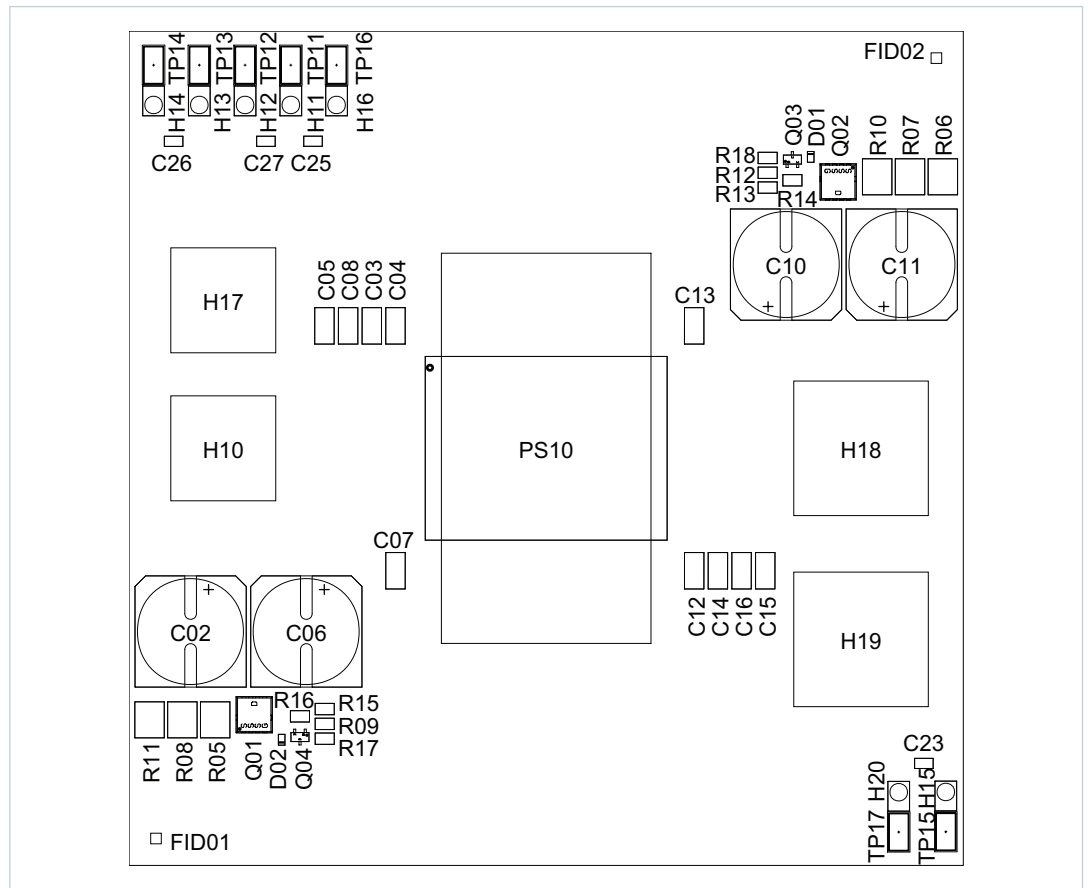
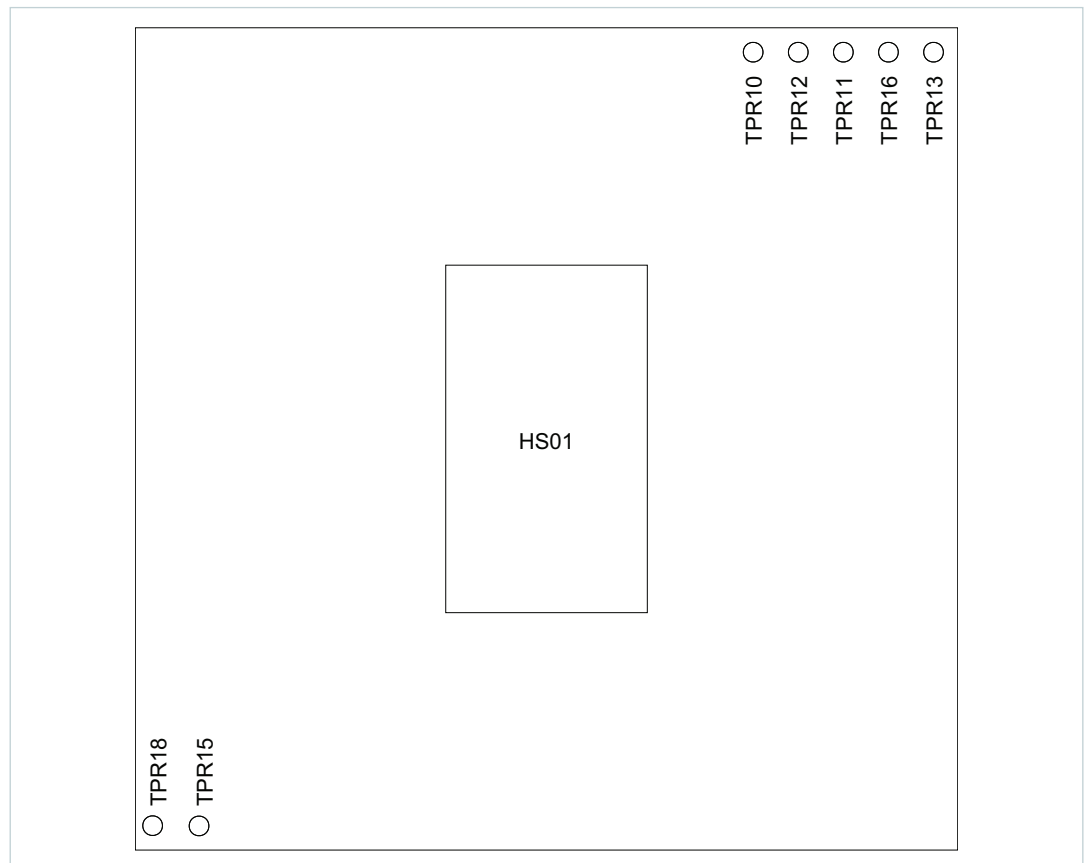

Figure 4b
PCB#47629 evaluation board
assembly drawing, bottom side



Bill of Materials

The following table describes the design-specific components of the NBM™ evaluation boards.

Table 2
NBM evaluation
board components

Reference Designator	Description	Manufacturer	Manufacturer Part Number	Notes
C26	Not applied			
C03, C04, C05, C07, C08	CAP X7R 2.2μF 10% 100V 1206	Murata	GRM31CR72A225KA73L	Low-ESR ceramic capacitor, HI side
C23	Not applied			
C12, C13, C14, C15, C16	CAP X6S 22μF 10% 25V 1206	Samsung Electro-Mechanics	CL31X226KAHN3NE	Low-ESR ceramic capacitor, LO side
C25, C27	Not applied			
HI-side pre-charge circuit components				
C02, C06	CAP ALEL POLY 68μF 20% 63V 10X10.5	Panasonic	EEH-ZC1J680P	HI-side pre-charge capacitance
R05, R08, R11	RES PULSE 51Ω 5% 3/4W 1210	Vishay	CRCW121051ROJNEAHP	High-pulse power rating required
Q01	QMOS N 60V 6.8mR 40A S308	Infineon	BSZ068N06NS	Used with NBM2317E54D1464TOR
	QMOS N 80V 7.0mR 40A S308_8		BSZ070N08LS5	Used with NBM2317E60E1560TOR
R09	RES 590kΩ 1/10W 1% 0603	KOA Speer	RK73H1JTDD5903F	
R15, R16, R17	RES 100kΩ 1/10W 1% 0603	KOA Speer	RK73H1JTDD1003F	
D02	DZEN 5.6V 2% 250mW SOD882	NXP	CZRQR5V6B-HF	
Q04	40V 200MA NPN SMALL SWITCHING TRANSISTOR (SOT-523)	Diodes Incorporated	MMBT3904T-7-F	
LO-side pre-charge circuit components				
C10, C11	CAP ALEL POLY 1000μF 20% 16V 10x12.4	Nichicon	RPS1C102MCN1GS	LO-side pre-charge capacitance
R06, R07, R10	RES PULSE 3.0Ω 1% 3/4W 1210	Vishay	CRCW12103R00FKEAHP	High-pulse power rating required
Q02	QMOS N 30V 2.0mR 40A S308	Infineon	BSZ0501NSI	
R12, R13, R18	RES 100kΩ 1/10W 1% 0603	KOA Speer	RK73H1JTDD1003F	
D01	DZEN 5.6V 2% 250mW SOD882	NXP	CZRQR5V6B-HF	
Q03	40V 200MA NPN SMALL SWITCHING TRANSISTOR (SOT-523)	Diodes Incorporated	MMBT3904T-7-F	
R14	Not applied			
Evaluation board demo assembly number				
PS10	Low-R _{OUT} Bidirectional NBM2317 SM-ChiP	Vicor	NBM2317S54D1464TOR	NBM2317D54D1464TOR
	Wide-range Bidirectional NBM2317 SM-ChiP	Vicor	NBM2317S60E1560TOR	NBM2317D60E1560TOR
PCB	SNGLTD PCB 2317 TC3 NBM DEMO	Vicor	47629	

Recommended Test Equipment

The following is a list of recommended test equipment:

1. Safety glasses
2. DC power supply: Refer to the specific NBM™ model data sheet to ensure the supply has sufficient power and current capability.
3. Electronic load: Refer to the specific NBM model data sheet to ensure the load has sufficient power handling and current capability for testing
4. Cooling fan
5. Digital multi-meters (DMMs)
6. Oscilloscope and probes
7. Interconnect wires, cables and fastening hardware

Basic Connections and Operation

- Confirm bench equipment is powered off.
- Connect the input DC power supply positive lead to the positive input lug of the evaluation board, connect the input power supply negative lead to the PGND input lug of the evaluation board. Please note that +V_{HI} is the positive input lug for step-down NBM operation and +V_{LO} is the positive input lug for step-up NBM operation. Given the wide bandwidth of the module, the source response is generally the limiting factor in the overall system response. Anomalies in the response of the power source will appear at the output of the module multiplied by its K factor. To take full advantage of the NBM's dynamic response, the impedance presented to its input terminals must be low from DC to approximately 5MHz. Use of a twisted pair of a suitable wire gauge is recommended to provide a low inductance interconnection to the power source. The connection of the NBM evaluation board to its power source should be implemented with minimal distribution inductance. If the interconnect inductance exceeds 50nH, additional capacitance should be placed at the source connection to the NBM evaluation board.
- Connect the positive output lug of the evaluation board to the electronic-load positive input, connect the PGND output lug of the evaluation board to the electronic-load negative input. Please note that +V_{LO} is the positive output lug for step-down NBM operation and +V_{HI} is the positive output lug for step-up NBM operation.
- Verify proper polarity of the connections.
- Verify all electrical termination fasteners are securely tightened to ensure a proper, low-impedance connection is made between the NBM evaluation board and the external power source and load.
- Direct airflow from the cooling fan across the NBM.
- Have the latest NBM data sheet on hand for reference.

Enable Options:

1. Apply input voltage to the NBM high-voltage side for step-down operation or low-voltage side for step-up operation. Input voltage must be greater than the undervoltage lockout and within the NBM start-up input voltage range.
2. External EN Control using available EN test point.

Please note that the board contains the pre-charge circuit at the output. Therefore, the load turn on should be delayed until the output bulk capacitance is fully charged. Load should not be present at the start up of the NBM evaluation board to allow the completion of NBM and output pre-charge circuit soft start.

Power Down:

For quick discharge of bulk capacitance following removal of input power, an external bleeding resistor (1k Ω) can be used from both +V_{HI} to PGND and +V_{LO} to PGND.

Paralleling

The paralleling and current sharing capability of the devices can be demonstrated by using multiple evaluation boards and interconnecting the inputs, outputs and power grounds using wires of sufficient current handling capability to create a parallel array. All NBMs in a parallel array must be the same model. If synchronous start up is desired, interconnect the EN pins of all paralleled units. Current sharing of NBMs is achieved through droop-share method based on output resistance of the parallel NBM modules. It is essential that cable size and length are matched to minimize input and output interconnect impedance imbalances that would affect sharing accuracy.

Thermal Considerations

Note that the TM pin reports the temperature of the NBM™ controller and is not necessarily the hottest component within the NBM. To maintain the internal NBM temperature within the maximum 125°C of the product operating temperature range, it is recommended that the TM pin reported temperature not exceed 100°C during use in this demonstration assembly when cooled by natural or forced convection. Air-flow requirements for NBM evaluation board operation in an ambient temperature environment are given in Figure 5. The prescribed air flow maintains TM reported temperature at or below 100°C for the full NBM output current range.

The NBM evaluation board is provided affixed to a coldplate with screws. Verify all mechanical mounting fasteners of the NBM evaluation board and coldplate are securely tightened to ensure an uninterrupted thermal dissipation pathway.

Mounting fasteners include four screws inserted through the top side of the board and bottom side of the coldplate in the HS01 area (see Figure 4) into metal standoffs. Additional metal standoffs thermally interface the NBM evaluation board at the two PGND electrical connections H17 and H19, completing the thermal ground dissipation pathway. Ensure the respective mounting screws on the underside of the coldplate are securely fastened prior to operation of the NBM.

Figure 5
Output current versus
required airflow for
NBM2317S54D1464TOR
mounted on
evaluation board demo
assembly at 25°C ambient

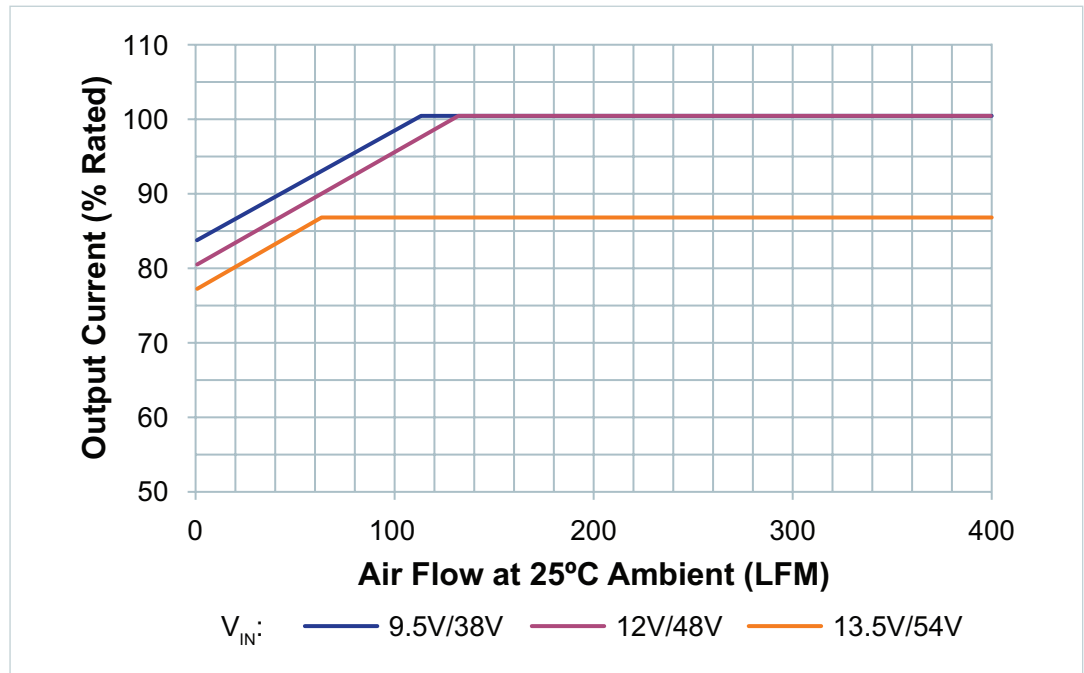

Figure 6
NBM™ evaluation board
mounted on coldplate



Limitation of Warranties

Information in this document is believed to be accurate and reliable. HOWEVER, THIS INFORMATION IS PROVIDED "AS IS" AND WITHOUT ANY WARRANTIES, EXPRESSED OR IMPLIED, AS TO THE ACCURACY OR COMPLETENESS OF SUCH INFORMATION. VICOR SHALL HAVE NO LIABILITY FOR THE CONSEQUENCES OF USE OF SUCH INFORMATION. IN NO EVENT SHALL VICOR BE LIABLE FOR ANY INDIRECT, INCIDENTAL, PUNITIVE, SPECIAL OR CONSEQUENTIAL DAMAGES (INCLUDING, WITHOUT LIMITATION, LOST PROFITS OR SAVINGS, BUSINESS INTERRUPTION, COSTS RELATED TO THE REMOVAL OR REPLACEMENT OF ANY PRODUCTS OR REWORK CHARGES).

Vicor reserves the right to make changes to information published in this document, at any time and without notice. You should verify that this document and information is current. This document supersedes and replaces all prior versions of this publication.

All guidance and content herein are for illustrative purposes only. Vicor makes no representation or warranty that the products and/or services described herein will be suitable for the specified use without further testing or modification. You are responsible for the design and operation of your applications and products using Vicor products, and Vicor accepts no liability for any assistance with applications or customer product design. It is your sole responsibility to determine whether the Vicor product is suitable and fit for your applications and products, and to implement adequate design, testing and operating safeguards for your planned application(s) and use(s).

VICOR PRODUCTS ARE NOT DESIGNED, AUTHORIZED OR WARRANTED FOR USE IN LIFE SUPPORT, LIFE-CRITICAL OR SAFETY-CRITICAL SYSTEMS OR EQUIPMENT. VICOR PRODUCTS ARE NOT CERTIFIED TO MEET ISO 13485 FOR USE IN MEDICAL EQUIPMENT NOR ISO/TS16949 FOR USE IN AUTOMOTIVE APPLICATIONS OR OTHER SIMILAR MEDICAL AND AUTOMOTIVE STANDARDS. VICOR DISCLAIMS ANY AND ALL LIABILITY FOR INCLUSION AND/OR USE OF VICOR PRODUCTS IN SUCH EQUIPMENT OR APPLICATIONS AND THEREFORE SUCH INCLUSION AND/OR USE IS AT YOUR OWN RISK.

Terms of Sale

The purchase and sale of Vicor products is subject to the Vicor Corporation Terms and Conditions of Sale which are available at: (<http://www.vicorpower.com/termsconditionswarranty>)

Export Control

This document as well as the item(s) described herein may be subject to export control regulations. Export may require a prior authorization from U.S. export authorities.

Contact Us: <http://www.vicorpower.com/contact-us>

Vicor Corporation

25 Frontage Road
Andover, MA, USA 01810
Tel: 800-735-6200
Fax: 978-475-6715
www.vicorpower.com

email

Customer Service: custserv@vicorpower.com
Technical Support: apps@vicorpower.com